

OWNER'S MANUAL

AIR CONDITIONER REMOTE CONTROLLER ILLUSTRATION

CS369-R5114
2200019089

Thank you very much for purchasing our air conditioner.
Please read this owner's manual carefully before using
your air conditioner.

CONTENTS

Handling the remote controller	1
Remote controller specification.....	2
Features of remote controller buttons	2
Indicators on display panel.....	5
AUTO operation.....	6
COOL/HEAT/FAN operation.....	7
DRY operation.....	7
TIMER operation.....	8
SLEEP button function.....	11
RESET and LOCK buttons function.....	12
DIRECTION/SWING button function.....	12
Cautions.....	13

Handling the remote controller

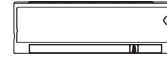

Location of the remote controller.

- Keep the remote controller where its signals can reach the receiver of the indoor unit. (a distance of 8m is allowed).
- When you select the timer operation, the remote controller automatically transmits a signal to the indoor unit at the specified time.
- If you keep the remote controller in a position that hinders proper signal transmission, a time lag of up to 15 minutes may occur.

CAUTIONS

- The air conditioner will not operate if curtains, doors or other materials block the signals from the remote controller to the indoor unit.
- Prevent any liquid from falling into the remote controller. Do not expose the remote controller to direct sunlight or heat.
- If the infrared signal receiver on the indoor unit is exposed to direct sunlight, the air conditioner may not function properly. Use curtains to prevent the sunlight from falling on the receiver.
- If other electrical appliances react to the remote controller, either move these appliances or consult your local dealer.

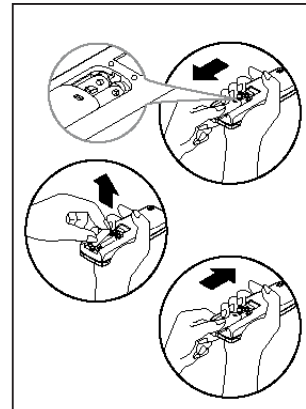

Replacing batteries

The remote controller uses two alkaline dry batteries (R03/LR03X2)

- (1) Slide the cover of the battery compartment off according to the arrow direction, then replace the old batteries with new ones.
- (2) Insert the new batteries making sure that the (+) and (-) of battery are installed correctly.
- (3) Reattach the cover by sliding it back into position.

NOTE:

Do not use old batteries or different type batteries or rechargeable batteries, otherwise it may cause the remote controller malfunction.

Remote Controller Specification

Model	R5114/BGE,R5114/BGCE, R51119/BGE, R51119/BGCE
Rated Voltage	3.0V(Dry batteries R03/LR03×2)
Lowest Voltage of CPU Emitting Signal	2.0V
Signal Receiving Range	8m (when using 3.0 voltage, it Gets 11m)
Environment	-5°C~60°C

Performance Features

1. Operating Mode: COOL,HEAT(Cooling only model without), DRY,FAN and AUTO .
2. Timer Setting Function in 24 hours.
3. Indoor Setting Temperature Range : 17°C~30°C.
4. Full function of LCD (Liquid Crystal Display)

Features of Remote controller buttons

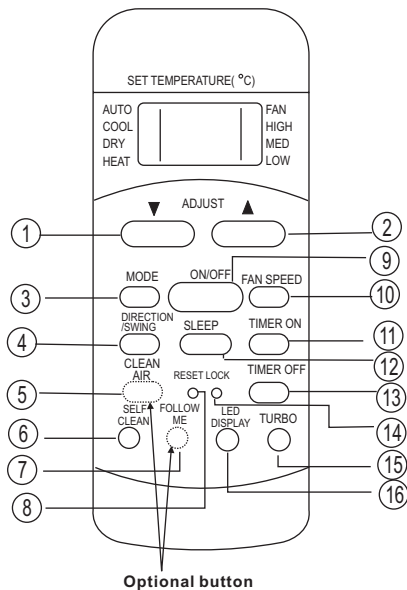

- ① **TEMP Button▼** : Push this button to decrease the indoor temperature setting in 1°C increments to 17°C.
- ② **TEMP Button▲** : Push this button to increase the indoor temperature setting in 1°C increments to 30°C.
- ③ **MODE Button**: Each time the button is pressed, the operation mode is selected in the sequence of the following:
 → AUTO → COOL → DRY → **HEAT** → FAN →

▲ **NOTE:** Heat mode is for cooling & heating models only.

- ④ **DIRECTION/SWING Button**: Press this button once and quickly to change the air flow direction of the horizontal louver a little. The moving angle of the louver is 6° for each press. Press the button without releasing for 2 more seconds, the horizontal louver would swing automatically. Press it again, it would stop moving. When the louver swing/moving at a certain position which would affect the cooling and heating effect of the air conditioner, it would automatically change the swing direction (upward or downward).
- ⑤ **CLEAN AIR Button(on some models)**: When push this button, the Ionizer/Plasma Dust Collector(depending on models) is energized and will help to remove pollen and impurities from the air.
- ⑥ **SELF CLEAN(AUTO CLEAN)Button**: Press this button under COOL or DRY mode, the self clean function is activated. Press it again will stop the operation and turn off the unit.
- ⑦ **FOLLOW ME Button(on some models)**: Push this button to initiate the Follow Me feature, the remote display is actual temperature at its location. The remote control will send this signal to the air conditioner every 3 minutes interval until press the Follow Me button again. The air conditioner will beep to indicate the Follow Me feature has ended if it does not receive the signal during any 7 minute interval.
- ⑧ **RESET Button**: Once the recessed RESET button is pressed, all of the current settings will be cancelled and the controller will return to the initial settings.
- ⑨ **ON/OFF Button**: Press this button to start the indoor unit. Press again to stop the unit.
- ⑩ **FAN SPEED Button**: Press the button to select the Fan speed in the sequence: AUTO, LOW, MED and HIGH. Each time the button is pressed, the fan speed selection is shifted.

- ⑪ **TIMER ON Button:** Press this button to activate the Auto-on time setting. Each press will increase the time setting in 30 minutes increments if the setting time is lower than 10 hours. When the setting time reaches 10h, each press will increase the time setting 1 hour in increments. To cancel the Auto-on time setting, just press the button until the time setting is 0.0.
- ⑫ **SLEEP Button:** Press this button to activate the Energy-Saving mode. Press again to stop the function. This function is available on COOL, HEAT or AUTO mode only and maintain the most comfortable temperature for you.
▲ NOTE: While the unit is running under SLEEP mode, it would be cancelled if any other buttons are pressed.
- ⑬ **TIMER OFF Button:** Press this button to activate the Auto-off time setting. Each press will increase the time setting in 30 minutes increments if the setting time is lower than 10 hours. When the setting time reaches 10h, each press will increase the time setting 1 hour in increments. To cancel the Auto-off time setting, just press the button until the time setting is 0.0.
- ⑭ **LOCK Button:** Press this recessed button to lock all current settings, and the remote controller will not accept any operation except that of the LOCK. Use the LOCK mode when you want to prevent settings from being changed accidentally. Press the LOCK button again to cancel the LOCK function. A lock symbol will appear on the remote controller display when the lock function is activated.
- ⑮ **TURBO Button:** Push this button to activate the Turbo function which enables the unit to reach the preset temperature in the shortest time. When press this button on cooling mode, the unit will blow strong cooling air with super high fan speed. When press this button on heating mode (applicable to the unit adopts PTC only), the PTC will be energized and bring fast heating operation.
Note: The unit system will automatically revert back to the previous settings after continue operating under powerful cooling mode for about half an hour.
- ⑯ **LED DISPLAY Button:** Press this button to clear the display on the indoor unit, press it again to light the display .

Indicators on display panel

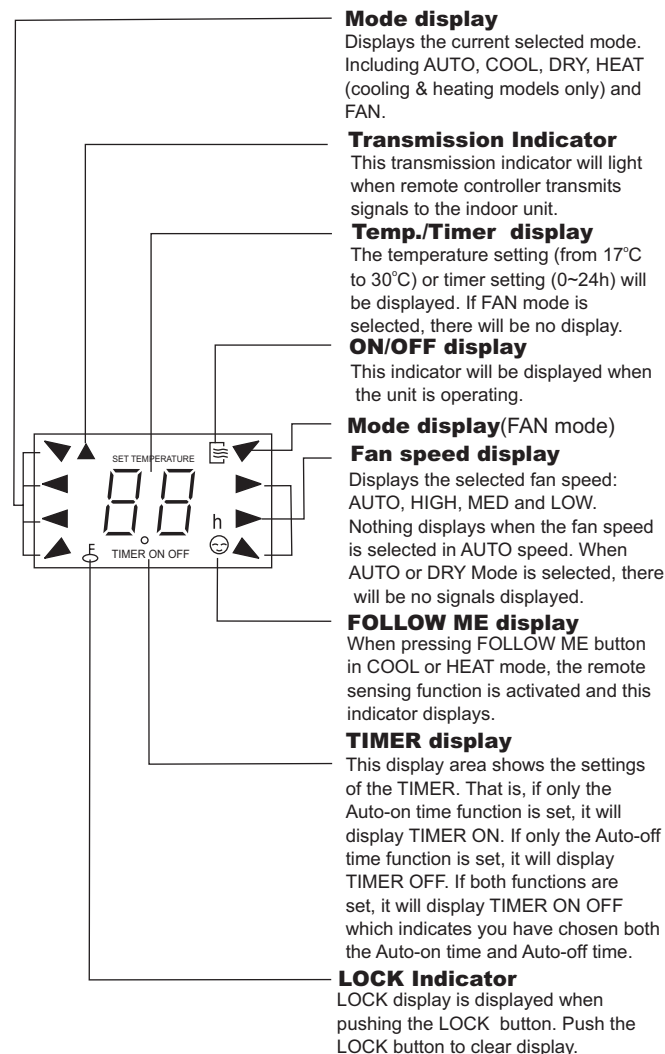

Auto operation

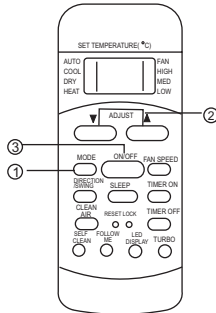

When you set the air conditioner in AUTO mode, it will automatically select cooling, heating (Cooling & Heating models only), or health operation depending on what temperature you have selected and the room temperature.

Once you select the operating mode, the operating conditions are saved in the unit's microcomputer memory. Thereafter, the air conditioner will start operating under the same conditions when you simply push the ON/OFF button of the remote controller.

Start

Ensure the unit is plugged in and power is available. The OPERATION indicator on the display window of the indoor unit illuminates.

1. Mode select button (MODE)
Press to select AUTO.
2. Temperature button (TEMP)
Set the desired temperature. Normally, set it between 21°C and 28°C.
3. ON/OFF button
Press the ON/OFF button to start the air conditioner.

Stop

ON/OFF button
Push this button again to stop the air conditioner.
If the AUTO mode is uncomfortable, you can select the desired conditions manually.
When you select the AUTO mode, you do not have to set the fan speed. The fan speed will be automatically controlled.

COOL/HEAT/FAN operation

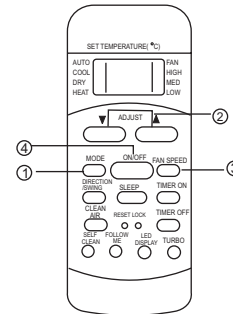

Start

Ensure unit is plugged and power is available.

1. Mode select button (MODE)
Press to select COOL, HEAT (Cooling & Heating models only), or FAN mode.
2. Temperature button (TEMP)
Set the desired temperature, the most comfortable temperature is between 21°C and 28°C.
3. Fan speed button (FAN SPEED)
Press to select "AUTO", "LOW", "MED" and "HIGH".
4. ON/OFF button
Press the ON/OFF button to start the air conditioner. The OPERATION indicator on the display panel of the indoor unit illuminates. The operating mode is selected in accordance with the room temperature and operation starts after approximately 3 minutes (If you select FAN mode, the unit will start immediately).

Stop

ON/OFF button
Push this button again to stop the air conditioner.

▲ NOTES: The temperature cannot be controlled under FAN only mode. While in this mode, only steps 1, 3 and 4 may be performed.

DRY operation

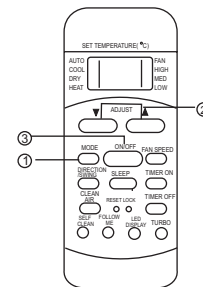

Start

Ensure unit is plugged and power is available. The OPERATION indicator on the display panel of the indoor unit starts flashing.

1. Mode select button (MODE)
Press to select DRY.
2. Temperature button (TEMP)
Push the "TEMP" button to set the desired temperature.
3. ON/OFF button
Press the ON/OFF button to start the air conditioner. No fan speed indicator displays. The Indoor fan speed will be automatically selected LOW.

Stop

ON/OFF button

Push this button again to stop the air conditioner.

Note: The fan speed cannot be adjusted when the unit is in AUTO and DRY mode.

▲ In DRY mode, due to the temperature difference between the setting temperature and the actual indoor temperature, the unit will automatically operate in COOL or FAN mode.

TIMER operation

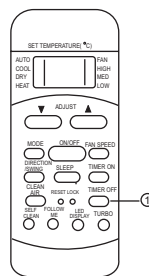
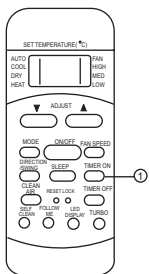

To press the TIMER ON button can set the auto-on time of the unit. To press the TIMER OFF button can set the auto-off time of the unit.

To set the Auto-on time.

1. Press the TIMER ON button. The remote controller shows TIMER ON, the last Auto-on setting time and the signal "h" will be shown on the LCD display area. Now it is ready to reset the Auto-on time to START the operation.
2. Push the TIMER ON button again to set desired Auto-on time. Each time you press the button, the time increases by half an hour between 0 and 10 hours and by one hour between 10 and 24 hours.
3. After setting the TIMER ON, there will be a one-half second delay before the remote controller transmits the signal to the air conditioner. Then, after approximately another 2 seconds, the signal "h" will disappear and the set temperature will re-appear on the LCD display window.

To set the Auto-off time.

1. Press the TIMER OFF button. The remote controller shows TIMER OFF, the last Auto-off setting time and the signal "h" will be shown on the LCD display area. Now it is ready to reset the Auto-off time to START the operation.
2. Push the TIMER OFF button again to set desired Auto-off time. Each time you press the button, the time increases by half an hour between 0 and 10 hours and by one hour between 10 and 24 hours.
3. After setting the TIMER OFF, there will be a one-half second delay before the remote controller transmits the signal to the air conditioner. Then, after approximately another 2 seconds, the signal "h" will disappear and the set temperature will re-appear on the LCD display window.

CAUTION

- When you select the timer operation, the remote controller automatically transmits the timer signal to the indoor unit for the specified time. Therefore, keep the remote controller in a location where it can transmit the signal to the indoor unit properly.
- The effective operation time set by the remote controller for the timer function is limited to the following settings: 0.5, 1.0, 1.5, 2.0, 2.5, 3.0, 3.5, 4.0, 4.5, 5.0, 5.5, 6.0, 6.5, 7.0, 7.5, 8.0, 8.5, 9.0, 9.5, 10, 11, 12, 13, 14, 15, 16, 17, 18, 19, 20, 21, 22, 23 and 24.

Example of timer setting

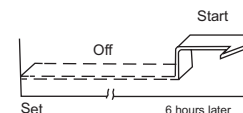

TIMER ON (Auto-on Operation)

The TIMER ON feature is useful when you want the unit to turn on automatically before say when you return home. The air conditioner will automatically start operating at the set time.

Example:

To start the air conditioner in 6 hours.

1. Press the TIMER ON button, the last setting of starting operation time and the signal "h" will show on the display area.
2. Press the TIMER ON button to display "6:0h" on the TIMER ON display of the remote controller.
3. Wait for 0.5 second and the TIMER ON indicator stops flashing and this function is activated. The digital display area will show the temperature again.

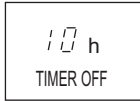

TIMER OFF (Auto-off Operation)

The TIMER OFF feature is useful when you want the unit to turn off automatically after you go to bed. The air conditioner will stop automatically at the set time.

Example:

To stop the air conditioner in 10 hours.

1. Press the TIMER OFF button, the last setting of stopping operation time and the signal "h" will show on the display area.
2. Press the TIMER OFF button to display "10h" on the TIMER OFF display of the remote controller.
3. Wait for 0.5 second and the TIMER OFF indicator stops flashing and this function is activated. The digital display area will show the temperature again.

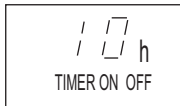
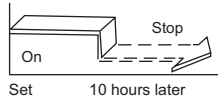

COMBINED TIMER (Setting both ON and OFF timers simultaneously)

TIMER OFF → TIMER ON

(On → Stop → Start operation)

This feature is useful when you want to stop the air conditioner after you go to bed, and start it again in the morning when you wake up or when you return home.

Example:

To stop the air conditioner 2 hours after setting and start it again 10 hours after setting.

1. Press the TIMER OFF button.
2. Press the TIMER OFF button again to display 2.0h on the TIMER OFF display.
3. Press the TIMER ON button.
4. Press the TIMER ON button again to display 10h on the TIMER ON display.
5. Wait for the remote control to display the setting temperature.

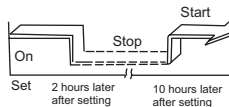

TIMER ON → TIMER OFF

(Off → Start → Stop operation)

This feature is useful when you want to start the air conditioner before you wake up and stop it after you leave the house.

Example:

To start the air conditioner 2 hours after setting, and stop it 5 hours after setting.

1. Press the TIMER ON button.
2. Press the TIMER ON button again to display 2.0h on the TIMER ON display.
3. Press the TIMER OFF button.
4. Press the TIMER OFF button again to display 5.0h on the TIMER OFF display.
5. Wait for the remote control to display the setting temperature.

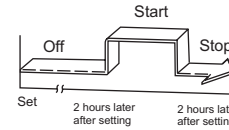

CAUTION

- The timer setting(TIMER ON or TIMER OFF) that in sequence occurs directly after the set time will be activated first.
- If the same time is set for both TIMER ON and TIMER OFF settings, no timer operation is performed. The air conditioner may stop operating, either immediately or after approximately 10 minutes.

SLEEP button function

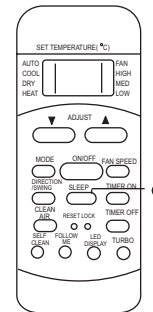

When you press the SLEEP button, the economic running function will be activated. During Cooling, Heating or AUTO operation, the set temperature of the air conditioner will automatically increase or decrease 1°C per hour for 2 hours. After 2 hours, the set point will continue at that temperature and the fan motor will be set to LOW speed. The sleep mode function can maintain the most comfortable temperature and save more energy for you.

NOTE: The SLEEP function is only available under Cooling, Heating and AUTO operation.

RESET and LOCK buttons function

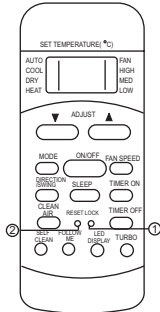

1. When you press the recessed LOCK button, all current settings are locked in and remote controller does not accept any operation except that of the LOCK. Use the LOCK mode when you want to prevent settings from being changed accidentally. Press the LOCK button again when you want to cancel the LOCK mode. A lock symbol will appear on the bottom right hand side of the remote controller display when the LOCK function is activated.
2. When you press the recessed RESET button, all current settings are cancelled and return to original factory settings.

DIRECTION/SWING button function

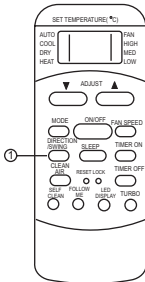

Use the DIRECTION/SWING button to activate AUTO swing function and lock louver in desired position.

1. When press this button once and quickly, the air flow direction setting feature of the louver is activated. The moving angle of the louver is 6° for each press. Keep pressing the DIRECTION/SWING button to move the louver to the desired position.
2. When press the button without releasing for 2 more seconds, the auto swing feature of the louver is activated. The horizontal louver would swing automatically. Press it again to stop.

NOTE: When the louver swing or move to a position which would affect the cooling and heating effect of the air conditioner, it would automatically change the swing/moving direction (upward or downward).

Cautions

1. When replacing batteries, do not use old batteries or different type batteries. Otherwise it may cause the remote controller to malfunction.
2. If you do not use the remote controller for a few weeks or more, remove the batteries. Otherwise, battery leakage may damage the remote controller.
3. The average battery life during normal use is approximately half a year. Replace the batteries when there is no receiving beep from the indoor unit or if the transmission indicator on the remote controller fails to light.
4. Be sure there are no barriers between the remote controller and the receiver of indoor unit otherwise the air conditioner will not work.
5. Keep the Remote Controller away from all liquids.
6. Protect the Remote Controller from high temperatures and exposure to radiation.
7. Keep the indoor receiver out of direct sunlight or the Air Conditioner may malfunction.
8. Keep controller away from EMI (Electro-Magnetic Interference) supplied by other household appliances.