

AIR CONDITIONER
REMOTE CONTROLLER ILLUSTRATION

The design and specifications are subject to change without prior notice for product improvement. Consult with the sales agency or manufacturer for details.

CR034-RG36F
202055091154
20101111

Thank you very much for purchasing our air conditioner.
Please read this owner's manual carefully before using
your air conditioner.

CONTENTS

Handling the remote controller	2
Remote controller Specifications.....	3
Function buttons	5
Indicators on LCD	7
How to use the buttons	8
Auto operation.....	8
Cooling/Heating/Fan operation.....	8
Dehumidifying operation	9
Adjusting air flow direction.....	9
Timer operation.....	10
SLEEP/FRESH function.....	13
LED/FOLLOW ME function	14
TURBO/SELF CLEAN function	14

Handling the remote controller

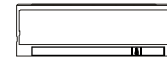

Location of the remote controller.

- Use the remote controller within a distance of 8 meters from the appliance, pointing it towards the receiver. Reception is confirmed by a beep.
- Keep the remote controller where its signals can reach the receiver of the unit. When you select the timer operation, the remote controller automatically transmits a signal to the indoor unit at the specified time. If you keep the remote controller in a position that hinders proper signal transmission, a time lag of up to 15 minutes may occur.

CAUTIONS

- The air conditioner will not operate if curtains, doors or other materials block the signals from the remote controller to the indoor unit.
- Prevent any liquid from falling into the remote controller. Do not expose the remote controller to direct sunlight or heat.
- If the infrared signal receiver on the indoor unit is exposed to direct sunlight, the air conditioner may not function properly. Use curtains to prevent the sunlight from falling on the receiver.
- If other electrical appliances react to the remote controller, either move these appliances or consult your local dealer.

Replacing batteries

The remote controller is powered by two dry batteries(R03/LR03X2) housed in the rear part and protected by a cover.

- (1) Remove the cover by pressing and sliding off.
- (2) Remove the old batteries and insert the new batteries,placing the(+) and (-) ends correctly.
- (3) Reattach the cover by sliding it back into position.

NOTE: When the batteries are removed, the remote controller erases all programming. After inserting new batteries, the remote controller must be reprogrammed.

CAUTIONS

- Do not mix old and new batteries or batteries of different types.
- Do not leave the batteries in the remote controller if they are not going to be used for 2 or 3 months.
- Do not dispose batteries as unsorted municipal waste. Collection of such waste separately for special treatment is necessary.

Remote Controller Specifications

Model	RG36F/BG(C)EF
Rated Voltage	3.0V(Dry batteries R03/LR03×2)
Signal Receiving Range	8m (when using 3.0 voltage, it gets 11m)
Environment	-5°C~60°C

Performance Feature

1. Operating Mode: AUTO, COOL, DRY, HEAT(Cooling only model without), and FAN.
2. Timer Setting Function in 24 hours.
3. Indoor Setting Temperature Range : 17°C~30°C.
4. Full function of LCD (Liquid Crystal Display).

NOTE:

- Buttons design might be slightly different from the actual one you purchased depending on individual models.
- All the functions described are accomplished by the indoor unit. If the indoor unit has no this feature, there is no corresponding operation happened when press the relative button on the remote controller.

RG36F/BG(C)EF

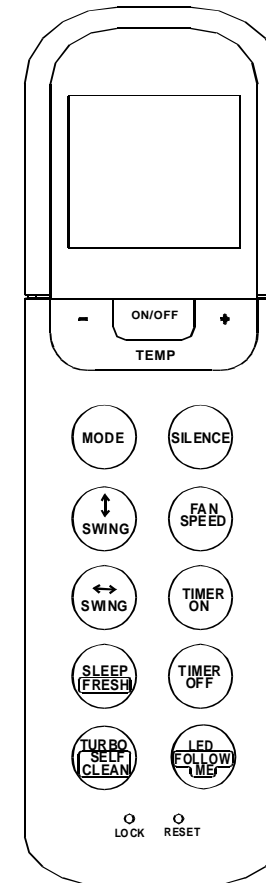

Function buttons

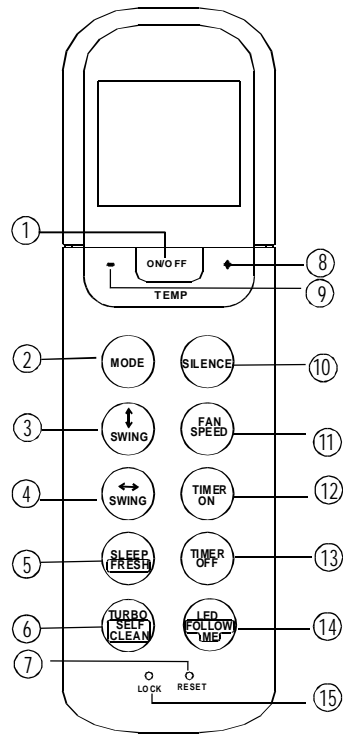

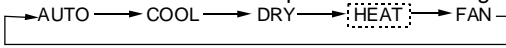
- ① **ON/OFF Button**
Operation starts when this button is pressed and stops when this button is pressed again.
- ② **MODE Button**
Each time the button is pressed, the operation mode is selected in a sequence of following:

- NOTE:** Heat mode is for Cooling & Heating models only.
- ③ **Swing ↕ Button**
Used to stop or start horizontal louver movement or set the desired up/down air flow direction. The louver changes 6 degree in angle for each press. If keep pushing more than 2 seconds, the louver will swing up and down automatically.
- ④ **Swing ⇔ Button**
Used to stop or start vertical louver movement and set the desired left/right air flow direction. The vertical louver changes 6 degree in angle for each press. And the temperature display area of indoor unit displays '↑↓' for one second. If keep pushing more than 2 seconds, the vertical louver swing feature is activated. And the display area of indoor unit displays 'IIII', flashes four times, then the temperature setting reverts back. If the vertical louver swing feature is stopped, it displays 'LC' and remains on for 3 seconds.
- ⑤ **SLEEP/FRESH Button**
Active/Disable SLEEP function. If pushing more than 2 seconds, the 'FRESH' function will be activated, pushing more than 2 seconds again to disable.
NOTE: While the unit is running under SLEEP mode, it would be cancelled if press the MODE, FAN SPEED or ON/OFF button.
- ⑥ **TURBO/SELF CLEAN Button:**
Active/Disable TURBO function. If pushing more than 2 seconds, the 'SELF CLEAN' function will be activated, pushing more than 2 seconds again to disable.
- ⑦ **RESET Button:**
When you press the recessed RESET button, all current settings are cancelled and the control will return to the initial settings.

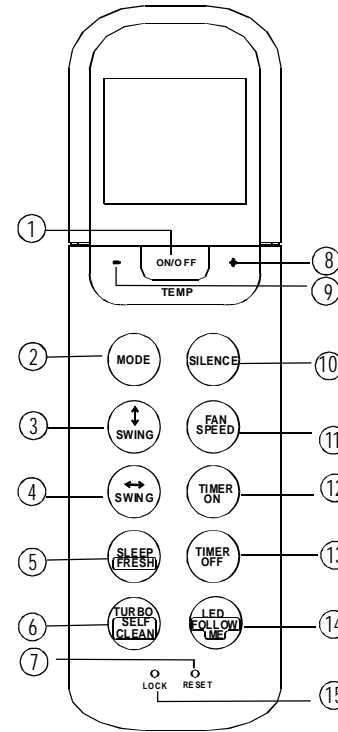
5

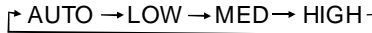

- ⑧ **UP Button(~/+)**
Push this button to increase setting temperature or to increase Hour during Timer setting.
- ⑨ **DOWN Button(▼/-)**
Push this button to decrease setting temperature or to decrease Hour during Timer setting.
- ⑩ Press this button to initiate SILENCE function. When the Silence function is activated, the indoor unit will bring faint breeze, which will reduce the noise to the lowest level and create a quiet and comfortable room for you.
- ⑪ **FAN SPEED Button**
Used to select the fan speed in four steps:

- ⑫ **TIMER ON Button**
Press this button to initiate the auto-on time sequence. Each press will increase the auto-timed setting in 30 minutes increments. When the setting time displays 10:00, each press will increase the auto-timed setting 60 minutes increments. To cancel the auto-timed program, simply adjust the auto-on time to 0:00.
- ⑬ **TIMER OFF Button**
Press this button to initiate the auto-off time sequence. Each press will increase the auto-timed setting in 30 minutes increments. When the setting time displays 10:00, each press will increase the auto-timed setting 60 minutes increments. To cancel the auto-timed program, simply adjust the auto-off time to 0:00
- ⑭ **LED/FOLLOW ME Button**
Disable/Active indoor screen Display. When pushing more than 2 seconds, the 'FOLLOW ME' function will be activated, pushing more than 2 seconds again to disable.
- ⑮ **LOCK Button**
When you press the recessed LOCK button, all current settings are locked in and the remote controller does not accept any operation except that of the LOCK. Press again to cancel the LOCK mode.

6

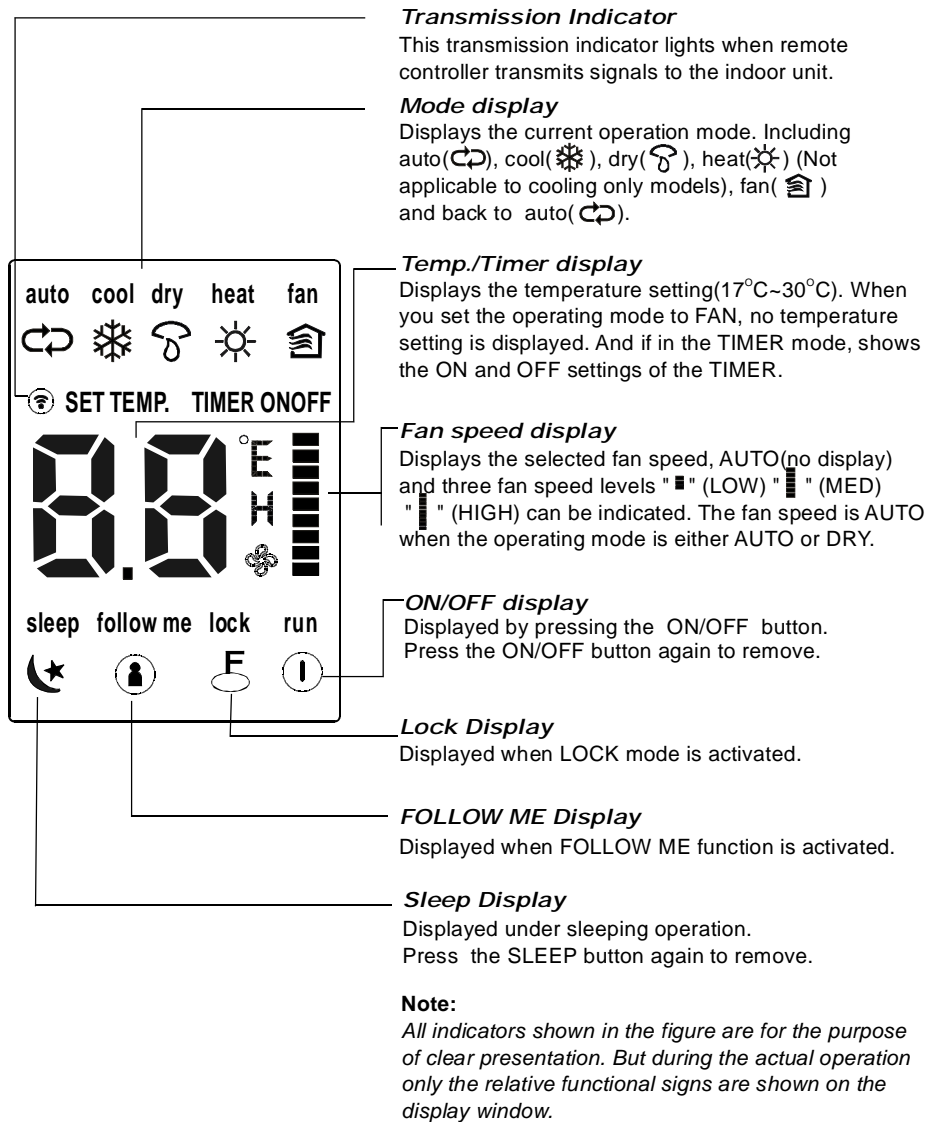
Indicators on LCD



7

How to use the buttons

Auto operation

Ensure the unit is plugged in and power is available. The OPERATION indicator on the display panel of the indoor unit starts flashing.

1. Press the **MODE** button to select Auto.
2. Press the **UP/DOWN** button to set the desired temperature. The temperature can be set within a range of 17°C~ 30°C in 1°C increments.
3. Press the **ON/OFF** button to start the air conditioner.

NOTE

1. In the Auto mode, the air conditioner can logically choose the mode of Cooling, Fan, and Heating by sensing the difference between the actual ambient room temperature and the setting temperature on the remote controller.
2. In the Auto mode, you can not switch the fan speed. It has already been automatically controlled.
3. If the Auto mode is not comfortable for you, the desired mode can be selected manually.

Cooling /Heating/Fan operation

Ensure the unit is plugged in and power is available.

1. Press the **MODE** button to select COOL, HEAT(cooling & heating models only) or FAN mode.
2. Press the **UP/DOWN** buttons to set the desired temperature. The temperature can be set within a range of 17°C~ 30°C in 1°C increments.
3. Press the **FAN** button to select the fan speed in four steps- Auto, Low, Med, or High.
4. Press the **ON/OFF** button to start the air conditioner.

NOTE

In the FAN mode, the setting temperature is not displayed in the remote controller and you are not able to control the room temperature either. In this case, only step 1, 3 and 4 may be performed.

8

Dehumidifying operation

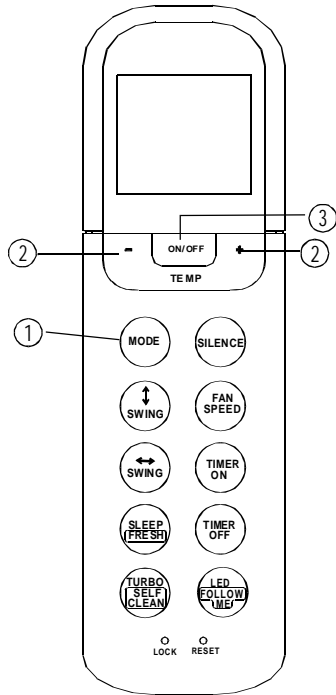

- Ensure the unit is plugged in and power is available. The OPERATION indicator on the display panel of the indoor unit starts flashing.
1. Press the **MODE** button to select DRY mode.
 2. Press the **UP/DOWN** buttons to set the desired temperature. The temperature can be set within a range of 17°C~ 30°C in 1°C increments.
 3. Press the **ON/OFF** button to start the air conditioner.

NOTE

In the Dehumidifying mode, you can not switch the fan speed. It has already been automatically controlled.

Adjusting air flow direction

Use the SWING \updownarrow and SWING \leftrightarrow buttons to adjust the desired airflow direction.

1. When push the SWING \updownarrow button, the horizontal louver changes 6 degree in angle for each push. If pushing more than 2 seconds, the louver will automatically swing up and down.
2. When push the SWING \leftrightarrow button, the vertical louver changes 6 degree in angle for each push. If pushing more than 2 seconds, the louver will automatically swing left and right.

NOTE: When the horizontal/vertical louver swing or move to a position which would affect the cooling or heating effect of the air conditioner, it would automatically change the swing/moving direction.

Timer operation

Press the **TIMER ON** button can set the auto-on time of the unit. Press the **TIMER OFF** button can set the auto-off time of the unit.

To set the Auto-on time.

1. Press the **TIMER ON** button. The remote controller shows **TIMER ON**, the last Auto-on setting time and the signal "h" will be shown on the LCD display area. Now it is ready to reset the Auto-on time to **START** the operation.
2. Push the **TIMER ON** button again to set desired Auto-on time. Each time you press the button, the time increases by half an hour between 0 and 10 hours and by one hour between 10 and 24 hours.
3. After setting the **TIMER ON**, there will be a one second delay before the remote controller transmits the signal to the air conditioner. Then, after approximately another 2 seconds, the signal "h" will disappear and the set temperature will re-appear on the LCD display window.

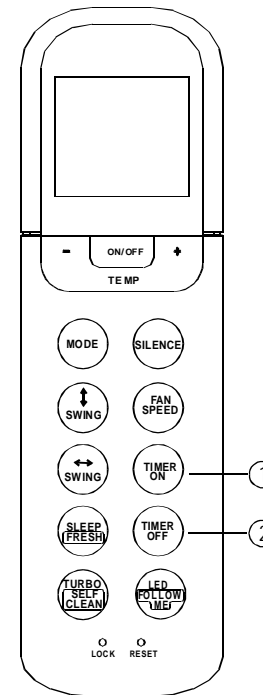

To set the Auto-off time.

1. Press the **TIMER OFF** button. The remote controller shows **TIMER OFF**, the last Auto-off setting time and the signal "h" will be shown on the LCD display area. Now it is ready to reset the Auto-off time to stop the operation.
2. Push the **TIMER OFF** button again to set desired Auto-off time. Each time you press the button, the time increases by half an hour between 0 and 10 hours and by one hour between 10 and 24 hours.
3. After setting the **TIMER OFF**, there will be a one second delay before the remote controller transmits the signal to the air conditioner. Then, after approximately another 2 seconds, the signal "h" will disappear and the set temperature will re-appear on the LCD display window.

CAUTION

- When you select the timer operation, the remote controller automatically transmits the timer signal to the indoor unit for the specified time. Therefore, keep the remote controller in a location where it can transmit the signal to the indoor unit properly.
- The effective operation time set by the remote controller for the timer function is limited to the following settings: 0.5, 1.0, 1.5, 2.0, 2.5, 3.0, 3.5, 4.0, 4.5, 5.0, 5.5, 6.0, 6.5, 7.0, 7.5, 8.0, 8.5, 9.0, 9.5, 10, 11, 12, 13, 14, 15, 16, 17, 18, 19, 20, 21, 22, 23 and 24.

Example of timer setting



TIMER ON (Auto-on Operation)

The TIMER ON feature is useful when you want the unit to turn on automatically before you return home. The air conditioner will automatically start operating at the set time.

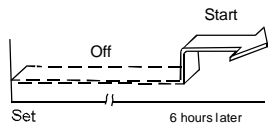

Example:

- To start the air conditioner in 6 hours.
1. Press the TIMER ON button, the last setting of starting operation time and the signal "h" will show on the display area.
 2. Press the TIMER ON button to display "6:0h" on the TIMER ON display of the remote controller.
 3. Wait for 3 seconds and the digital display area will show the temperature again. The "TIMER ON" indicator remains on and this function is activated.



TIMER OFF (Auto-off Operation)

The TIMER OFF feature is useful when you want the unit to turn off automatically after you go to bed. The air conditioner will stop automatically at the set time.

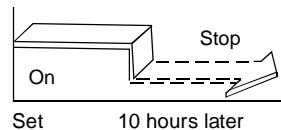

Example:

- To stop the air conditioner in 10 hours.
1. Press the TIMER OFF button, the last setting of stopping operation time and the signal "h" will show on the display area.
 2. Press the TIMER OFF button to display "10h" on the TIMER OFF display of the remote controller.
 3. Wait for 3 seconds and the digital display area will show the temperature again. The "TIMER OFF" indicator remains on and this function is activated.

COMBINED TIMER

(Setting both ON and OFF timers simultaneously)

TIMER OFF → TIMER ON (On → Stop → Start operation)

This feature is useful when you want to stop the air conditioner after you go to bed, and start it again in the morning when you wake up or when you return home.

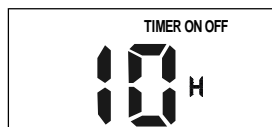

Example:

- To stop the air conditioner 2 hours after setting and start it again 10 hours after setting.
1. Press the TIMER OFF button.
 2. Press the TIMER OFF button again to display 2.0h on the TIMER OFF display.
 3. Press the TIMER ON button.
 4. Press the TIMER ON button again to display 10h on the TIMER ON display .
 5. Wait for 3 seconds and the digital display area will show the temperature again. The "TIMER ON OFF" indicator remains on and this function is activated.

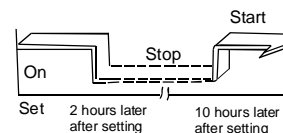

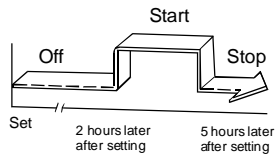

TIMER ON → TIMER OFF

(Off → Start → Stop operation)

This feature is useful when you want to start the air conditioner before you wake up and stop it after you leave the house.

Example:

To start the air conditioner 2 hours after setting, and stop it 5 hours after setting.

1. Press the TIMER ON button.
2. Press the TIMER ON button again to display 2.0h on the TIMER ON display.
3. Press the TIMER OFF button.
4. Press the TIMER OFF button again to display 5.0h on the TIMER OFF display.
5. Wait for 3 seconds and the digital display area will show the temperature again. The "TIMER ON OFF" indicator remains on and this function is activated.

NOTE: The timer setting(TIMER ON or TIMER OFF) that in sequence occurs directly after the set time will be activated first.

SLEEP/FRESH function

- Press this button less than 2nds will initiate SLEEP function. And if keep pressing this button more than 2nds, the FRESH function is initiated.
- The sleep function enables the unit to automatically increase(cooling) or decrease(heating) 1°C per hour for the first two hours, then hold steady for the next 5 hours, after that the unit will stop operation. It can maintain the most comfortable temperature and save energy.
NOTE: The SLEEP function is only available under Cooling, Heating and AUTO operations.
- When the FRESH function is initiated, the Ionizer/Plasma Dust Collector(dependent on models) is energized and will help to remove pollen and impurities from the air.

LED/FOLLOW ME function

- Press this button less than 2nds will initiate LED function. And if keep pressing this button more than 2nds, the FOLLOW ME function is initiated.
- When the Follow Me function is activated, the remote display is actual temperature at its location. The remote control will send this signal to the air conditioner every 3 minutes interval until press the FOLLOW ME button again.
- The Follow Me function is not available under DRY and FAN mode.
- Switch the operation mode or turn off the unit will cancel the Follow Me function automatically.

TURBO/SELF CLEAN function

- Press this button less than 2nds will initiate TURBO function. And if keep pressing this button more than 2nds, the SELF CLEAN function is initiated.
- Turbo function enables the unit to reach the preset temperature in the shortest time. When press this button on cooling mode, the unit will blow strong cooling air with super high fan speed. When press this button on heating mode (applicable to the unit adopts PTC only), the PTC will be energized and bring fast heating operation.
- Under SELF CLEAN mode, the air conditioner will automatically clean and dry the Evaporator and keep it as fresh for the next operation.

